



POST-TENSIONED IN BUILDINGS

General Objectives in Building Design
Applications of Post-Tensioning
in Building Structures
The VSL Hardware for Use in Buildings
Details and Layouts Improving the
Constructability
Preliminary Sizing
of Post-Tensioned Floors
Examples

4.1

VSL REPORT SERIES

PUBLISHED BY
VSL INTERNATIONAL LTD.

Preface

The development of reliable prestressing techniques has certainly been the most important innovation in the field of structural concrete. It enabled concrete construction to compete successfully within areas that had previously been dominated by steel construction, including long-span bridges, high-rise buildings, pressure vessels and offshore structures. Today, prestressing and, in particular, post-tensioning is a mature technology, providing efficient, economic and elegant structural solutions for a wide range of applications.

Surveys indicate vast differences in the use of post-tensioning among different countries. While the wide spread can largely be explained by differences in local needs, standards, education and habits it appears that the potential offered by post-tensioning is far from being exploited, especially in building structures. Too many building structures, for which post-tensioning would provide a clearly superior solution, are conceived, designed and built as non-prestressed. For too long, non-prestressed and prestressed concrete have been treated as completely separate entities and hence, prestressing is not yet regarded as a familiar and desirable construction option by many developers, architects, engineers and contractors.

Post-tensioning in buildings is not limited to floor slabs. Post-tensioning of foundations, transfer beams and plates, post-tensioned masonry and the combination of precast elements with cast-in-place concrete by means of post-tensioning offer other interesting opportunities. Developers, architects, engineers, contractors, educators and students will find the present report to be most informative in this regard. It describes the application of post-tensioning within the overall context of building construction and it yields a sufficient basis for corresponding preliminary designs; special information required for the final dimensioning and detailing will be given in a companion report.

VSL should be commended for continuing their tradition to disseminate state-of-the art information on post-tensioning and it is hoped that through this and related efforts an increasing number of companies and individuals will benefit from the use of posttensioning in buildings.

Zurich, 30th April 1992

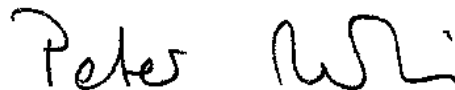
A handwritten signature in black ink, appearing to read 'Peter Marti', with a stylized flourish at the end.

Prof. Dr. Peter Marti
ETH Zurich

Contents

1.	Introduction	2
2.	General Objectives in the Design of Building Structures	4
3.	Applications of Post-Tensioning in Buildings.....	10
	3.1 Floor Systems	10
	3.2 Moment-Resisting Frames	16
	3.3 Transfer Beams and Transfer Plates	18
	3.4 Wall Panels and Service Cores.....	19
	3.5 Post-Tensioned Foundations and Ground Anchors	21
	3.6 Post-Tensioned Masonry Walls.....	22
	3.7 Other Applications	22
4.	The VSL hardware for Use in Building Structures.....	23
	4.1 The System	23
	4.2 To Grout or not to Grout?	23
5.	Preliminary Sizing of Post-Tensioned Floors.....	25
6.	Details Improving the Constructability of Post-Tensioned Floors	27
7.	Examples	30
8.	References	37

Authors:

Franz A. Zahn, PhD, Dipl. Ing. Hans R. Ganz, Dr. sc. techn., Civil Engineer ETH

1. Introduction

It is no secret that the key to the successful construction of new buildings is successful planning. Successful planning starts from the very beginning with good communication and close cooperation between all parties involved in the project, in particular the owner, the architect and the engineer. As soon as a contractor has been nominated he too should be included in the planning team. In this way one of the key aspects of successful planning, the constructability of the building, can be addressed properly as part of the evaluation process of various concepts. This is of paramount importance for the success of the project since constructability most markedly affects the time to completion of a turn-key project and thus the final cost to the owner. Because the major part of the total cost of large developments is financing cost rather than actual construction cost, the completion time is often a more important consideration than material consumption. With this in mind it follows that successful planning means to always maintain an overall perspective of the project, that is to consider the building as a whole rather than looking at individual parts in isolation. Since the various parts of a building strongly influence one another, in particular in the way they are constructed, optimization of one part may well be detrimental to another.

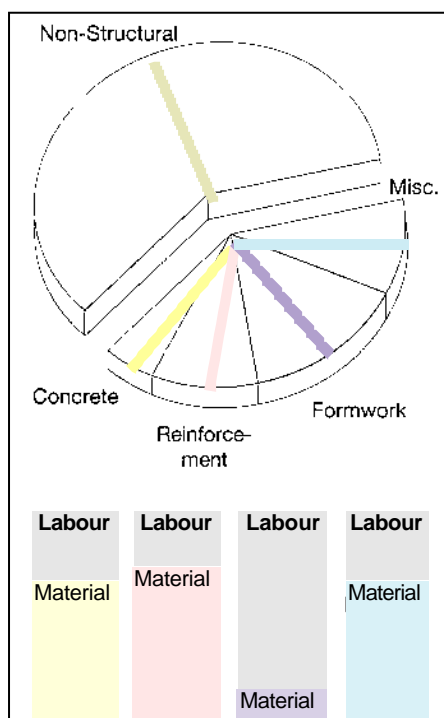

Fig. 1.1: Split-up of Total Cost for Buildings

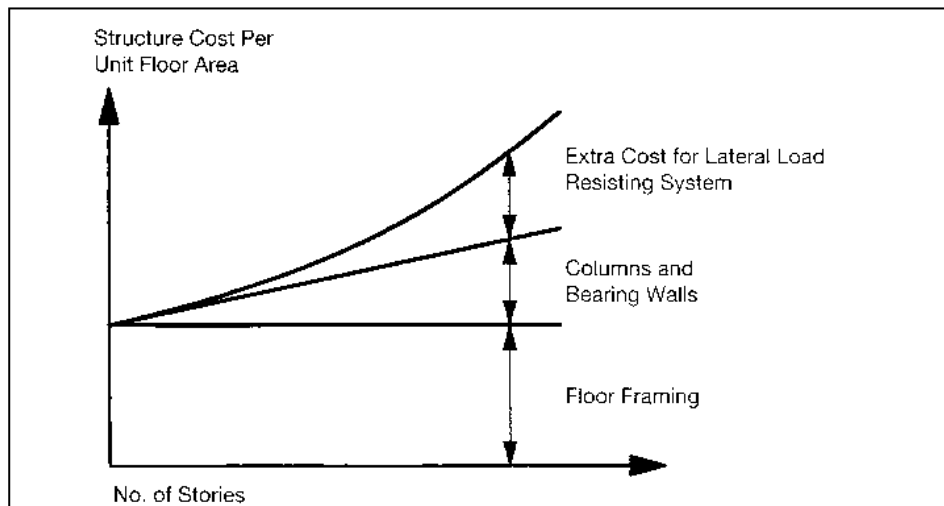

Fig. 1.2: Contribution of Floor Framing to Total Structural Cost [1]

another, in particular in the way they are constructed, optimization of one part may well be detrimental to another.

Even when considering only the construction costs (Fig. 1.1), it is evident that optimization of structural material consumption alone will result in relatively modest overall savings since on one hand the structural cost makes only about 30 to 50% of the total construction cost and on the other hand more than half of the structural cost is labour cost, related mainly to formwork.

Any significant saving in construction cost can therefore only be achieved by means that also affect the labour cost and the non-structural cost for cladding, electrical and mechanical services, lifts, fit-out, etc.

The most cost significant structural element of a building is the floor framing. Fig. 1.2 demonstrates the relative contribution of the floor framing to the total structural cost per unit floor area. While for low-rise buildings this contribution is almost 100%, the cost for columns and walls including their foundations, and for the lateral load resisting system becomes increasingly significant for taller buildings. The floor framing system affects the cost in two ways:

First it has a direct influence on the rest of the structure in that its weight determines the size of columns, walls and foundations, and its structural depth determines the total building height and thereby the quantity of cladding

and vertical trunk lines. In seismic areas the floor weight also determines the member sizes of the lateral load resisting system. Fig. 1.3 shows the split-up of the total structural weight of a 49-storey building. While the floor framing accounts for just over 50% of the total, any reduction of floor weight would cause a corresponding weight reduction also for the peripheral frames and the service core and would thus affect almost the entire structural weight.

The second way the floor framing system affects the cost of the building relates to the total construction time: Both the time required to construct one floor and the time lag between the structural completion of the floor and the commencement of fit-out work such as electrical and mechanical services, suspended ceilings and decorating, are major factors influencing the time to completion of the building. These considerations demonstrate that the optimization of the floor framing with regard to weight, structural depth and constructability goes a long way towards successful planning. However, one should not make the mistake of comparing the cost of one floor system against the cost of another without considering the array of effects on other parts of the structure, including the non-structural parts, and on financing cost.

In some countries, including the U.S., Australia, South Africa and Thailand, a great number of large buildings have been successfully constructed using posttensioned floors. One of the main reasons

for this success is the improved constructability of post-tensioned slabs: less material to be handled and placed, simpler and less congested reinforcement, earlier stripping of formwork and often simpler formwork. Apart from shorter overall construction time and savings in material and labour cost, post-tensioning allows more architectural freedom: Larger columnfree spaces providing more flexibility in the subdivision of commercial and office floors, wide-spanning or boldly cantilevering floors that leave generous space for lobbies or public areas, slender elegant roofs for show rooms or exhibition halls, to name a few examples.

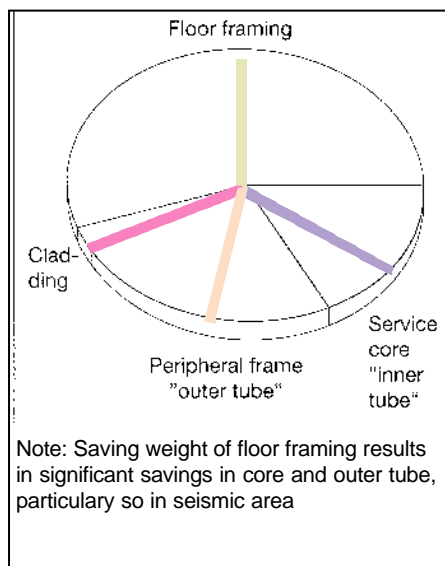

Fig. 1.3: Split-up of Total Structural Weight for a 49 Storey Office Building of the "Tube-in-Tube" Type (adopted from [2])

In addition, the reduction of structural height and weight as outlined above, and the improved deflection and cracking behaviour contribute to the success of post-tensioned floors.

Fig. 1.4 shows the total post-tensioning consumption and the percentage used in buildings in various countries in the year 1990. It is evident that there are huge differences. While in the U.S. and Australia more than 75 % of the total post-tensioning was built into building structures, this market made less than 10 % in most European countries. The objective of this report is to encourage the use of post-tensioning in buildings, particularly in countries where this idea is not yet

widely accepted, by demonstrating its advantages and benefits. The report is intended to provide useful background information to owners, architects, engineers and contractors, and to relate to them the positive experience made in areas where the use of post-tensioning in buildings is commonplace.

Specifically, Chapter 2 summarises the major design objectives, including suggestions how these objectives can be met. This should help the reader to rationally select an efficient overall structural concept for a building. Then, in Chapter 3 a wide range of post-tensioning applications are illustrated, including foundations, structural walls and service cores, moment-resisting frames, transfer beams and plates, and masonry walls. In recognition of their key role in building structures, floor framing systems are discussed in greater depth. These illustrations demonstrate that post-tensioning can make a significant contribution to the success of building designs. After a brief review of the VSL post-tensioning hardware in Chapter 4, Chapter 5 presents some background information to enable the reader to determine preliminary sizes of floor framing members, and to estimate approximate reinforcing and prestressing steel quantities. The content is not intended to serve as a design aid to engineers. Technical design issues will be the subject of the second volume of this report. Tendon arrangements, connection and anchorage details for post-tensioned floors are discussed in Chapter 6. Finally,

Chapter 7 presents two examples that reiterate the contents of Chapters 3, 5 and 6. While post-tensioning is a very attractive repair and strengthening method, this report is limited to applications in new construction.

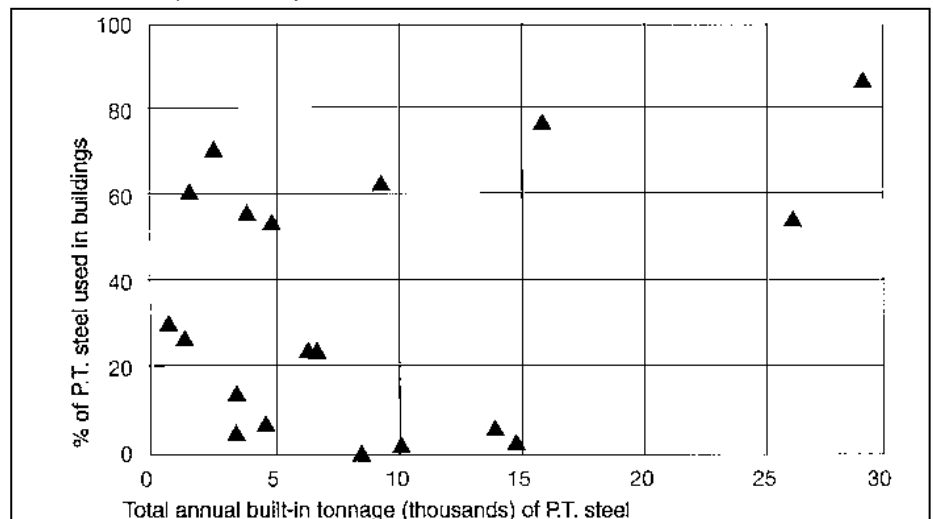

Fig. 1.4: Total Annual Post-Tensioning Consumption and Percentage Used in Building Structures in Various Countries (1990 Figures)

2. General Objectives in the Design of Building Structures

Buildings can be classified in many different ways. They can be distinguished by their use or occupancy, by the construction materials, by their owners (public / private), or by their height (low-rise / high-rise). Here two representative building types, distinguished primarily by

trunk lines, the storey height and therefore the structural height of the floor framing must be minimised. In order to maximise rentable space and flexibility of occupancy the floor framing is usually required to have relatively long spans, which is in conflict with the objective to

and deflection limitations or avoidance of expansion joints.

Tables 2.1 and 2.2 also include suggestions as to how each design objective can be met. These suggestions include



Fig. 2.1: Typical High-Rise Building under Construction



Fig. 2.2: Typical Low-Rise Building under construction

the predominant direction in which the construction progresses, are used to demonstrate some general objectives to be considered in the conceptual design.

For typical medium to high-rise office or multi-purpose buildings similar to the example shown in Fig. 2.1, the construction progresses vertically, floor by floor. The high repetition rate of identical floors and the floor-by-floor construction sequence imply a number of design objectives typical for this type of building. Table 2.1 summarises some of these objectives and how the project benefits if the objectives are met. For instance, in order to minimise the overall construction time, one of the prime design objectives must be to achieve a fast floor cycle, that is to minimise the time required to complete a floor. In order to minimise the size of vertical members and foundations the floor weight must be kept as low as possible. In order to save on cladding, vertical structural members and vertical service

minimise structural floor height and weight.

For typical large area, low to medium-rise buildings similar to the one shown in Fig. 2.2, the predominant direction of construction progression is horizontal, with some simultaneous vertical progression. The completion of an entire floor is therefore not on the critical path to the same extent as for high-rise buildings. Also, the repetition rate of identical floors, and the total number of floors is usually relatively small so that the structural height and the weight of the floor framing do not normally play as significant a role as they do in the design of high-rise buildings. Table 2.2 summarises some of the design objectives for this type of building and the corresponding benefits for the project. While the design objectives related to the constructability are similar to those listed for high-rise buildings, the different usage of low-rise buildings, e.g. industrial, retail, parking, often implies some specific requirements such as strict cracking

the use of simple and efficient formwork, post-tensioning, pre-fabrication of reinforcing assemblages, complete or partial pre-fabrication of entire concrete elements, the choice of a suitable floor framing system, simple details, high degree of standardization, and the use of high early strength concrete.

Post-tensioning helps to meet each single one of the design objectives. The reasons for this are different in each case and are listed as foot notes under the tables. The most prominent ones are that post-tensioning allows the floor framing to be more slender, solving the problem of the conflicting needs for long spans and small structural depth, and that it replaces a significant amount of reinforcement, thus reducing steel quantities and allowing standardization and simplification of the reinforcement. Further reasons why post-tensioning helps to improve the design are that usually the concrete quantities are reduced and that the

Table 2.1: Objectives Of Concrete Floor Design

**Medium to High-Rise Office
and Multi-Purpose, Building**

characteristic construction progression: vertical

Overall Objective	Benefits for the project	Benefits for the project
smallest-possible floor-to floor height	<ul style="list-style-type: none"> • saving on vertical structural members, cladding, mechanical risers, lift stairs, air conditioning (volume to be heated or cooled) 	<ul style="list-style-type: none"> • post-tensioning 1)
largest-possible columnfree space, i. e. long spans	<ul style="list-style-type: none"> • flexibility of occupancy, • maximum rentable space 	
lowest-possible weight of floor	<ul style="list-style-type: none"> • saving on vertical structural members and foundation and, in seismic areas, on lateral load resisting system 	<ul style="list-style-type: none"> • light-weight concrete • ribbed or waffle slab • slab with voids • post-tensioning 2)
high repeatability from floor to floor	<ul style="list-style-type: none"> • improvement of constructability and thus saving of time 	<ul style="list-style-type: none"> • simple, standardised details for reinforcement • simple, standardised details for formwork • post-tensioning 3)
quickest-possible floor cycle	<ul style="list-style-type: none"> • saving of time • avoidance of clashes between different trades • reduction of required number of formwork sets 	<ul style="list-style-type: none"> • high early strength concrete • simple reinforcing and formwork in large pre-assembled units • simple details with high repeatability • pre-fabrication of critical path elements (columns, beams, slab soffits, or walls) • post-tensioning 3) 4) 5)
no back-propping wherever possible	<ul style="list-style-type: none"> • direct saving of time, indirect saving of time by allowing building fit-out to start earlier (early access) 	<ul style="list-style-type: none"> • use of self-supporting falsework that only needs to be supported near vertical elements • high early strength concrete • post-tensioning 6)

Why does post-tensioning help to meet the design objectives?

- | | |
|---------------------------------------------------------------------------------------------------------------------------------------------------------------------------------------------------------------------------------------------------------------------------------------------------------------------------------------------------------------------------------------------------------------------------------------------------------------------------------------------------------------------------------------------------------------------|-------------------------------------------------------------------------------------------------------------------------------------------------------------------------------------------------------------------------------------------------------------------------------------------------------------------------------------------------------------------------------------------------------------------------------------------------------------------------------------------------------------------------------------------------------------|
| <p>1) post-tensioning allows greater span/depth ratio</p> <p>2) for a given span post-tensioned floors require less concrete</p> <p>3) if a significant part of the load is resisted by post-tensioning the non-prestressed reinforcement can be simplified and standardised to a large degree. Furthermore, material handling is reduced since the total tonnage of steel (non-prestressed + prestressed) and concrete is less than for a R. C. floor</p> <p>4) post-tensioning allows earlier stripping of formwork</p> | <p>5) assembling of precast elements by post-tensioning avoids complicated reinforcing bar connections with insitu closure pours, or welded steel connectors, and thus can significantly reduce erection time</p> <p>6) usually the permanent floor load is largely balanced by draped post-tensioning tendons so that only the weight of the wet concrete of the floor above induces flexural stresses. These are often of the same order as the design live load stresses. Hence back-propping of one floor below is usually sufficient</p> |
|---------------------------------------------------------------------------------------------------------------------------------------------------------------------------------------------------------------------------------------------------------------------------------------------------------------------------------------------------------------------------------------------------------------------------------------------------------------------------------------------------------------------------------------------------------------------|-------------------------------------------------------------------------------------------------------------------------------------------------------------------------------------------------------------------------------------------------------------------------------------------------------------------------------------------------------------------------------------------------------------------------------------------------------------------------------------------------------------------------------------------------------------|

POST-TENSIONED IN BUILDINGS

Table 2.2: Objectives Of Concrete Floor Design

**Low to Medium-Rise, Large Area
Multi-Purpose Commercial Buildings**

characteristic construction progression: predominantly horizontal, in one or two directions

Overall Objective	Benefits for the Project	How the objectives can be met
large column-free spaces, i.e. large spans	<ul style="list-style-type: none"> flexibility of occupancy, maximum rentable space 	<ul style="list-style-type: none"> post-tensioning
high repeatability from stage to stage and from floor to floor	<ul style="list-style-type: none"> improvement of constructability and thus saving of time 	<ul style="list-style-type: none"> simple, standardised details for reinforcement simple, standardised details for formwork post-tensioning 2)
quickest-possible turn around of formwork	<ul style="list-style-type: none"> saving of time reduction of required number of formwork sets 	<ul style="list-style-type: none"> high early strength concrete simple reinforcing and formwork in large pre-assembled units simple details with high repeatability pre-fabrication of critical path elements (columns, beams, slab soffits, walls) post-tensioning 2)3)4)
no back-propping wherever possible	<ul style="list-style-type: none"> direct saving of time, indirect saving of time by allowing building fit-out to start earlier (early access) 	<ul style="list-style-type: none"> use of self-supporting falsework that only needs to be supported near vertical elements high early strength concrete post-tensioning 5)
for some commercial and industrial developments: strict deflection limitations	<ul style="list-style-type: none"> (requirement) 	<ul style="list-style-type: none"> pre-cambered formwork sufficient stiffness of multi-span floors post-tensioning high early strength concrete post-tensioning 5)
for some commercial and industrial developments: strict limitation of crack widths	<ul style="list-style-type: none"> (requirement) 	<ul style="list-style-type: none"> lay-out of columns and walls to avoid restraint of shrinkage and temperature shortening temporary or permanent separation of floor from restraining vertical elements careful concrete mix design careful curing of concrete well distributed non-prestressed steel post-tensioning 6)
for some warehouse or industrial buildings : floor free of expansion joint	<ul style="list-style-type: none"> improved riding surface, for fork lifts, easy-to-clean surfaces 	<ul style="list-style-type: none"> same as above
for parkings (typically): lowest-possible floor-to-floor height	<ul style="list-style-type: none"> more rentable space for given total building height. shorter ramps 	<ul style="list-style-type: none"> post-tensioning 1)

Why does post-tensioning help to meet the design objectives?

- 1) **post-tensioning** allows greater span/depth ratio, thus more economical for large spans
- 2) if a significant part of the load is resisted by **post-tensioning** the non-prestressed reinforcement can be simplified and standardised to a large degree. Furthermore, material handling is reduced since the total tonnage of steel (non-prestressed + prestressed) and concrete is less than for a R.C. floor
- 3) **post-tensioning** allows earlier stripping of formwork
- 4) assembling of precast elements by **post-tensioning** avoids complicated reinforcing bar connections with insitu closure pours, or welded steel connectors, and thus can significantly reduce erection time
- 5) usually the permanent floor load is largely balanced by draped **post-tensioning** tendons so that only the weight of the wet concrete of the floor above induces flexural stresses. These are often of the same order as the design live load stresses. Hence back-propping of one floor below is usually sufficient
- 6) **post-tensioning** usually balances most of the permanent loads thus significantly reducing deflections and tensile stresses
- 7) the P/A stress provided by **post-tensioning** may prevent tensile stresses causing the floor to crack.

formwork can be stripped earlier than for non-prestressed floors. Also, the often required strict limitation of deflections and crack widths can be effectively achieved by post-tensioning. Since the draped prestressing tendons typically balance a significant part of the permanent floor loading, deflections and cracking are substantially reduced compared to a reinforced floor. In addition, the in-plane compression forces from the prestressed tendons neutralize tensile stresses in the concrete to a degree, delaying the formation of cracks.

Another important factor that helps to speed up the overall construction time is the formwork. Large highly mechanized form systems for the floor framing, such as fly forms or table forms (Figs. 2.3 and 2.4) and climbing forms for wall systems such as service cores (Fig. 2.5) are typical examples of efficient formwork.

Pre-fabrication of large reinforcing assemblages, often including post-tensioning tendons and anchorages, is another good example of how the construction time can be reduced (Fig. 2.6). Pre-assembling of reinforcement is facilitated by the use of post-tensioning since steel quantities are reduced and reinforcing details can be simplified and standardized to a high degree.

Yet a higher level of rationalization is the partial or even complete pre-fabrication of entire concrete elements such as columns, beams, wall panels or slab soffits. In this way the setting up and stripping of formwork and the placing of steel and concrete is mainly carried out off the critical path, resulting in time saving and a smaller workforce required on the job itself. Some typical examples of precast elements are shown in Figs. 2.7 to 2.9: Precast columns, continuous over two storeys in Fig. 2.7, precast wall panels in Fig. 2.8 and precast columns with precast drop panels mounted on top in Fig. 2.9. This example demonstrates how a flat slab with drop panels can be constructed without a major increase of formwork complexity. Fig 2.10 shows an example of a one-way slab and band beam floor built entirely with precast concrete soffits and shell beams which will act compositely with the insitu concrete. Fig. 2.11 (a) shows three different types of shell beams. The possible arrangement

of post-tensioning tendons in the band beams and in the slab is also indicated in the diagrams. The precast elements normally contain most, if not all of the bottom reinforcement, including beam stirrups where needed, so that only the post-tensioning tendons and the top

reinforcement have to be placed on site. The shell beams can be combined with different types of slabs, ranging from insitu slabs cast on conventional formwork to proprietary precast floor panels such as



Fig. 2.3: Large "Flying Formwork" Panels



Fig. 2.4: "Flying Formwork" Panel Viewed from Inside of Floor under Construction

POST-TENSIONED IN BUILDINGS

hollow core or double T slabs, as shown in Fig. 2.11 (b).

Finally, a note on the concrete properties for post-tensioned parts of buildings. In general there is no need to specify higher

concrete strengths than for structural parts of normal reinforced concrete. However, in some cases the choice of high early strength concrete may lead to significant time savings since it allows earlier stripping of formwork. Because the stresses in a post-tensioned

slab or beam without super-imposed loading are typically very small, except for the local zones around the anchorages of the prestressing tendons, the prestress can be applied at a time when the concrete is still



Fig. 2.5: VSL Climbing Formwork is an Efficient Means to Construct Complex Service Cores in High-Rise Buildings



Fig. 2.6: Site Pre-Fabricated Reinforcement, Including Strand and Anchorages, Speed up Construction



Fig. 2.7: Another Example of Efficient Construction: 2-Storey Pre-Fabricated Concrete Columns

still quite "green", provided that the anchorage zones have sufficient strength. The use of larger bearing plates or of precast anchorage blocks containing standard anchorages, are two possible ways to allow early stressing and thus early formwork stripping even when normal strength concrete is used. In order to minimise shrinkage and creep related cracking of the young concrete it pays to use carefully formulated mixes and to properly cure the concrete for a sufficiently long period of time.



Fig. 2.8: ,Pecast Wall Panels



Fig. 2.8: Precast Wall Panels

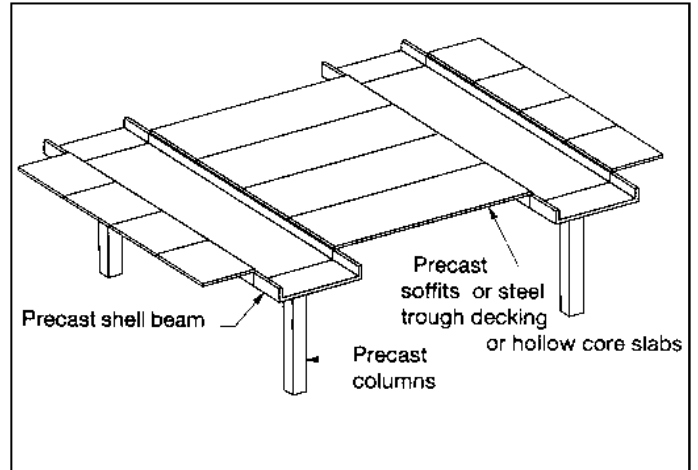

Fig. 2.10: Floor Framing Constructed with Integrated Formwork

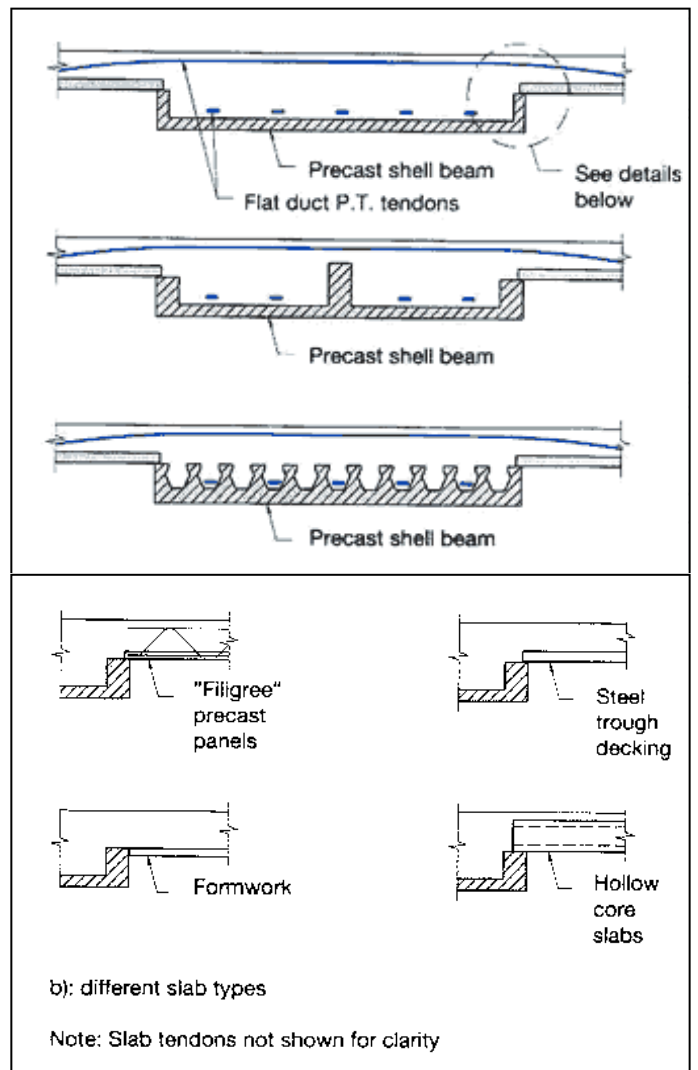

Fig. 2.11: Floor Framing with Integrated Formwork: Sections

3. Applications of Post-Tensioning in Buildings

Apart from floor systems there are many other possible applications of posttensioning in building structures that can result in significant savings. The list includes moment-resisting frames, shear walls, service cores, transfer beams and plates, foundations, masonry walls, hangers and ties. In this chapter each of these applications, as well as post-tensioned floor systems, are discussed in some detail. The advantages offered by posttensioning are reviewed and some typical tendon arrangements are shown for the different applications. Since floor systems have by far the greatest impact on the cost of building structures they are treated in more depth than the other applications presented.

3.1 Floor Systems

The multitude of different floor systems a designer can choose from are reviewed with respect to the selection criteria and the compatibility with post-tensioning. Floor systems can be classified in different ways, for instance insitu versus precast floors, single span versus multi span floors, slab on beams versus flat slab, one-way versus two-way systems, etc. Table 3.1 presents a classification into two main categories, namely **one-way systems** and **two-way systems**. Each of these is further sub-divided into different groups, depending on whether beams are used, and if so, whether the beams are of the wide shallow type often referred to as "**band beams**", or conventional **narrow beams** (including supporting walls as a limit case in terms of support stiffness for the slab). Each of these groups can then be further sub-divided by **slab type** (flat solid slab, flat voided slab, both with or without drop panels, ribbed slab, waffle slab), **beam type** (solid or voided beams, both with or without drop panels), and **construction method** (different combinations of insitu and partly precast construction, including the use of steel trough decking as composite slab formwork).

The selection of the floor framing system depends on **a number of factors**, the main ones being:

- **typical span range**
the suitability and economy of the different floor framing systems depend on the span length
- **ratio of span in x-direction to span in y-direction**
for nearly square column grids two-way systems are more suitable than one-way systems
- **super-imposed loading (light/ heavy)**
for heavy loading floor systems with beams are more suitable than flat slabs
- **overall structural height of the floor framing** determines the total building height and thus the cost for cladding and vertical services (particularly important for high-rise buildings)
- **constructability**
determines the overall construction time and thus the final cost to the owner economy of the floor system material consumption versus labour cost, relative cost of concrete, steel and formwork, local availability of proprietary systems such as double T, hollow core or similar
- **flexibility for the lay-out of under-ceiling mechanical/electrical services** free routing underneath the soffit versus penetrations through beams
- **structural weight per unit area (average)**
determines the size of vertical supporting members and foundations and, in seismic areas, of the lateral load resisting system. The use of ribbed slabs, waffle slabs or voided slabs helps to minimise the weight
- **requirements for in-service behaviour (deflections, cracking) and for strength** depending on these requirements stiffness, moment capacity, or both are important criteria
- **is the floor framing part of the lateral load resisting system?**
floor systems with beams are preferable if frame action is required
- **exposed soffits/ suspended ceilings**
flat plates or waffle slabs are more aesthetic where the soffit is exposed

"Constructability" incorporates a whole range of factors, including

- **whether or not large fly form panels or table forms can be lifted out through the sides of the completed floor**
if not the use of composite (lost) formwork such as precast concrete soffits and shell beams, or steel trough decking should be considered.
- **crane access and capacity**
this determines to what extent precast elements and large formwork units can be used
- **formwork cost and number of re-uses of identical forms in the building**
for many re-uses a higher level of form complexity can be justified economically
- **complexity of connection details**
connections between floor framing and previously cast parts, such as precast edge beams or wall panels, climb-formed service cores etc. deserve careful consideration
- **punching shear**
beams, drop panels or column capitals versus flat plate with punching shear reinforcement
- **are the floor edges straight or irregular with re-entrant corners?**
irregular and indented edges are simpler to form for flat slabs than for slab/beam systems

Table 3.2 summarises the main features, the advantages and disadvantages, and some possible post-tensioning arrangements for the floor systems of Table 3.1. The post-tensioning tendons are marked in blue. Depending on the system, it may be more economical to post-tension only the beams, or the slab, or both. For the floor systems with beams, only the ones with band beams are shown in Table 3.2. The arrangement of slab tendons in equivalent systems with narrow beams or supporting walls is similar. Naturally, narrow concrete beams, regardless of whether they are precast or cast-in-place, can also be post-tensioned. For systems 1 and 2 (Table 3.2) the tendons can either be concentrated in the "column strips", i. e. narrow bands along the grid lines, or they can be partly concentrated in the "column strips" and partly distributed in one or both directions. While column strip tendons are very easy to place, the arrangement shown as option (c) requires careful planning of the placing sequence since the tendons inter-weave. On the other hand, option (c) provides better in-service performance because the balancing loads from the draped tendons are more uniformly distributed. Option (b) thus appears to be a good compromise of the two.

Referring to Table 3.2 it is evident that for increasing span lengths and superimposed loads the use of auxiliary stiffening elements such as ribs, beams or drop panels increases the complexity of the floor framing, and thus the cost for formwork. However, even for light loading as for office floors the choice of a complex system may prove to be economical, particularly so for high-rise buildings. Compared to flat plates, floor systems with beams, ribs, drop panels or voids possess a better structural efficiency, that is flexural stiffness and strength for a given weight per unit floor area, hence the floor weight can be reduced significantly, resulting in savings for vertical members and foundations. On the other hand, the formwork is re-used many times in highrise buildings so that the complexity is relatively insignificant in terms of formwork cost per unit floor area. It should also be remembered that the combination of precast soffits, drop panels or shell beams with insitu concrete allows the construction of complex floor systems with rather simple, if any formwork, as shown in Figs. 2.9 to 2.11.

In Chapter 2 the general objectives in the design of building structures and the different ways in which post-tensioning can help to meet these objectives, were reviewed. The specific advantages of post-tensioning the floor framing are once more summarised below:

- **reduction of structural depth**
this in turn results in a reduced building height and corresponding savings in cladding and vertical services, or allows to fit additional storeys into the given maximum building height
- **increase of span length**
allows larger column-free areas and thus more flexibility in the floor use
- **reduction of floor weight and of material consumption**
the size of columns, walls and foundations is reduced and less material is used for the floor framing itself
- **flexibility in layout of services**
with post-tensioning it is often possible to choose a floor system with a flat soffit while a corresponding reinforced concrete floor would need beams or ribs
- **improved constructability**
faster construction because less material is to be handled and placed. Simpler details, higher degree of standardization, less congestion of reinforcement, often minimum reinforcement that can be pre-assembled in large units
- **improved cracking and deflection control**
Due to the load-balancing effect of the draped prestressing tendons a typical post-tensioned floor is more or less free of flexure under its self weight, i.e. virtually no tensile stresses and deformations exist. Cracking and deflections are almost exclusively caused by super-imposed and live loads (apart from volume change effects due to drying shrinkage and temperature changes) and are normally reversible when the loads are removed. Long-term (creep) deflections are thus mainly due to permanent super-imposed loads which are typically applied no sooner than 6 months after the floor was cast. Because the creep coefficient for long-term loads applied at that concrete age is much smaller than for loads acting from the start, the creep deflections of post-tensioned floors are further reduced compared to those expected for non-prestressed floors.

Are there any disadvantages? The short answer is no. One argument frequently used against post-tensioning by owners and contractors is the lack of flexibility to accommodate floor penetrations, either planned or as part of future changes to meet specific tenant requirements. For planned or future small penetrations the contrary is the case: Because of the reduced reinforcement content the rebars are usually spaced further apart, leaving more flexibility for small penetrations. There is no doubt that drilling or coring small holes into or through post-tensioned floors requires a certain amount of discipline in order to avoid cutting any post-tensioning strands. However, it is very simple to locate the tendons in a floor to make sure that small penetrations or fixing holes miss them. In most cases the construction drawings will give a good estimate where it is safe to drill. If the drawings show tendons close to the

proposed penetration then the exact tendon location can readily be determined on site with the aid of a metal detector. Drilling of small holes for fixing dowels is generally safe anywhere provided the drill has got an automatic switch that is triggered by contact with steel. Since the tendons usually have a minimum concrete cover of 30 to 50 mm small holes less than 20 to 30 mm deep can be drilled safely anywhere in the slab. Large penetrations for new stairs, lifts or air conditioning ducts require a careful design check by an engineer, regardless of whether the floor is post-tensioned or not. If the post-tensioning tendons are arranged in column strips or beams only, there are relatively large slab panels between these strips where there are no tendons at all so that penetrations can be readily accommodated with very little, if any additional strengthening.

POST-TENSIONED IN BUILDINGS

Table 3.1 Classification of floor systems

1-way-systems

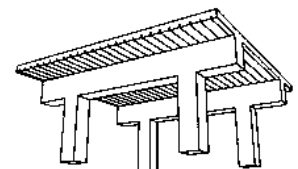
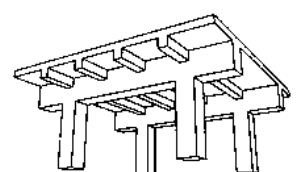
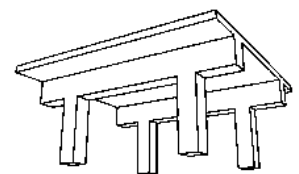
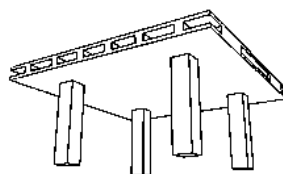
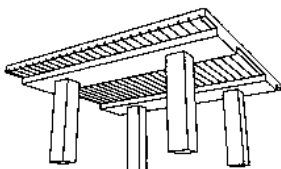
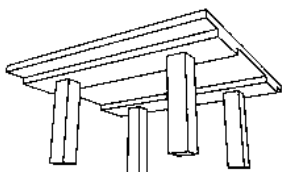
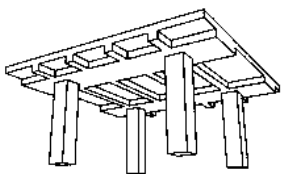
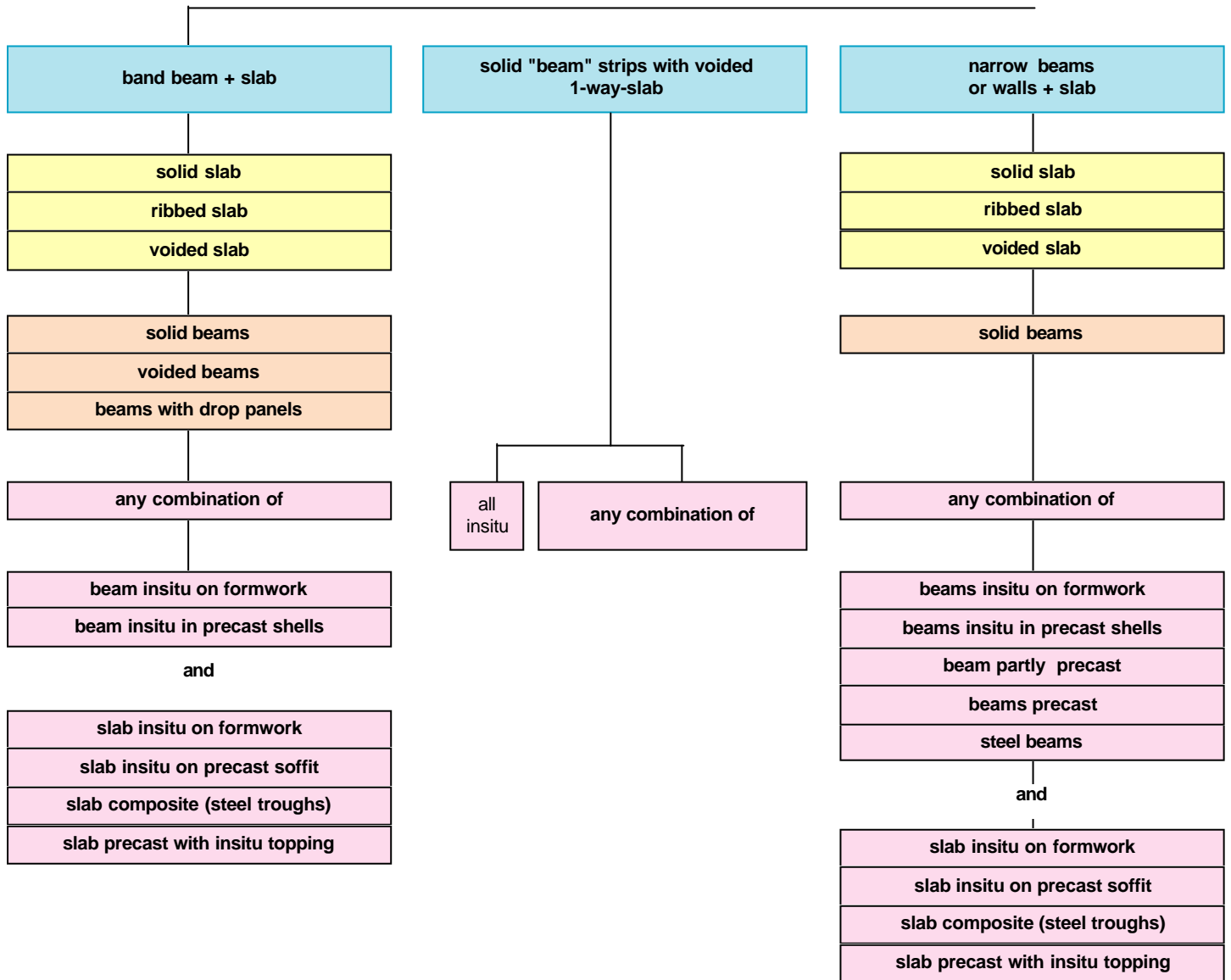
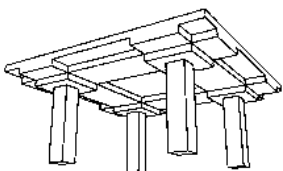
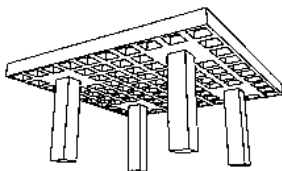
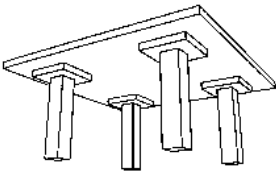
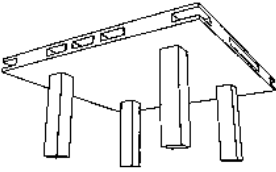
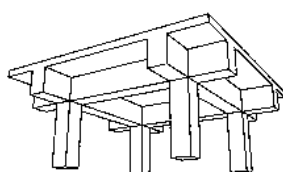
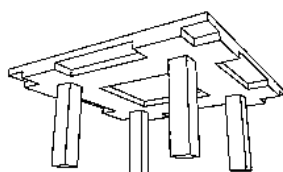
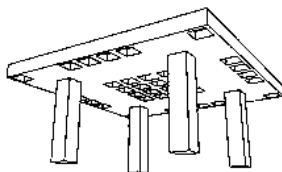
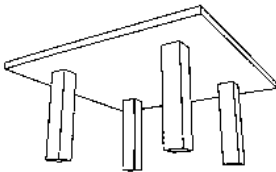
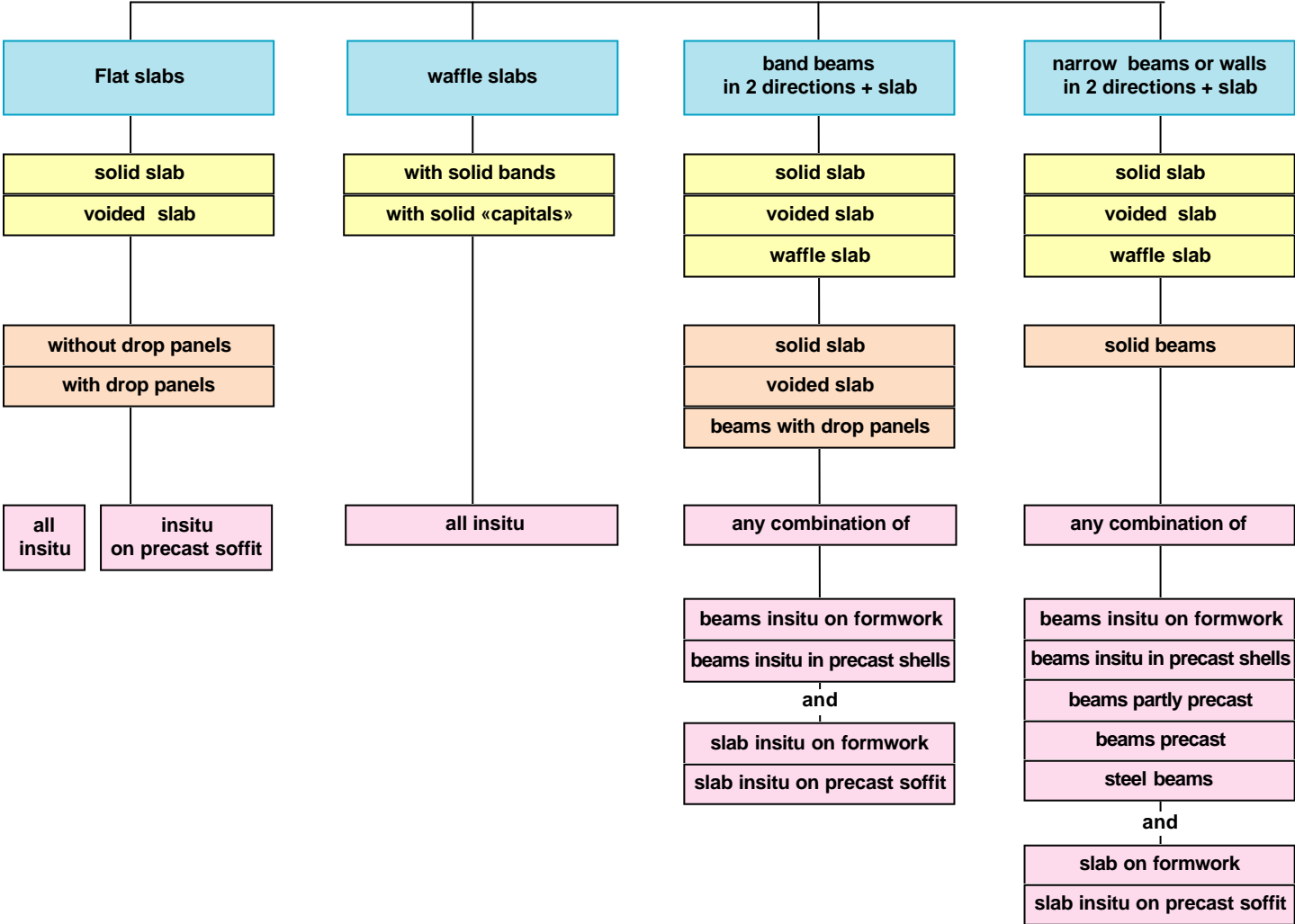

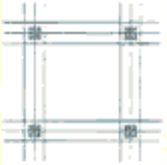
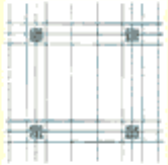
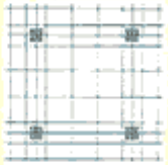
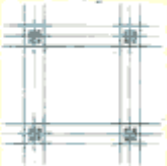
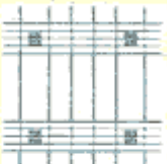
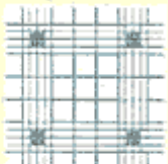
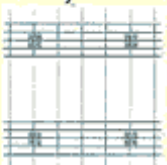
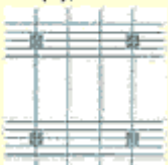

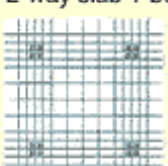
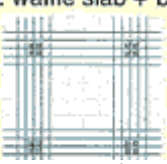

Table 3.1 Continued

2-way-systems



POST-TENSIONED IN BUILDINGS

Table 3.2

floor system and schematic arrangement of prestressing tendons	most suitable for span range (column centre-to-centre)	Suitable for loading light / medium / heavy*
<p>a: flat plate </p> <p>b: flat plate </p> <p>c: flat plate </p>	7-10 m	light to medium
<p>a: flat slab with drops </p> <p>b: flat slab with drops same tendon arrangement as 1 b</p> <p>c: flat slab with drops same tendon arrangement as 1 c</p>	8-13 m	light to medium
<p>a: flat plate with voids </p> <p>b: flat plate with voids </p> <p>note: (a) solid strips in one direction (b) solid strips in both directions</p>	7-12 m	light to medium
<p>a: 1-way slab + beams </p> <p>b: as (a), ribbed slab </p> <p>c: same as (a) but with narrow (conventional) beams</p> <p>d: same as (b) but with narrow (conventional) beams</p>	beams: 8-16 m slab: 7-12 m ribbed slab: 9-14 m	light to medium
<p>a: steel trough decking </p> <p>b: same as (a) but with conventional precast concrete beams</p> <p>c: same as (a) but with steel beams</p>	beams: 8-16 m slab: 7-12 m	light to medium
<p>a: 2-way slab + beams </p> <p>b: 2-way slab + beams </p> <p>c: same as (a) but with narrow (conventional) beams</p> <p>d: same as (b) but with narrow (conventional) beams</p>	8-16 m	medium to heavy
<p>a: waffle slab + "beams" </p> <p>b: waffle slab + "drops" </p>	10-20 m	medium to heavy

*light: 2-5 kN/m²; medium: 5-10 kN/m²; heavy: greater than 10 kN/m²

Table 3.2 (continued)

advantages	disadvantages	Remarks	
<p>lowest cost formwork, flexibility in column arrangement, flat ceiling, greatest flexibility for under-ceiling services layout</p> <ul style="list-style-type: none"> tendons in types (a) and (b) easy to place types (b) and (c) give best load-balancing (i. e. better deflection control) 	<p>low punching shear capacity, excess concrete for longer spans and unequal spans in x and y, greater deflections than other types</p> <ul style="list-style-type: none"> tendons in type (c) less easy to place type (a) less effective in load balancing 		1
<p>compared to (1): better punching shear capacity, less concrete consumption for longer spans or heavier loading, less congested top reinforcement over columns</p> <ul style="list-style-type: none"> tendon arrangements see under (1) 	<p>expensive formwork</p> <ul style="list-style-type: none"> for tendon arrangements see under (1) sensitive to pattern loading 	<p>drop panels are typically one third of the span length with a total thickness of 1.5 to 2 times the slab thickness</p>	2
<p>has got all the advantages of (1) but less weight (important in seismic zones), or, for same weight longer spans possible. for same weight, loading and spans punching shear capacity and deflections are better compared to (1)</p> <ul style="list-style-type: none"> tendon arrangement (a) easy to place 	<p>handling, placing and material cost of void formers</p> <ul style="list-style-type: none"> tendon arrangement (b) less easy to place 	<p>attractive in combination with precast soffits</p>	3
<p>same as (2), longer spans possible in one direction, lighter floor or longer slab span possible with ribbed slab</p> <ul style="list-style-type: none"> tendons are easy to place and very effective for load-balancing 	<p>more expensive formwork than (1), even more so for ribbed slab, less flexible services layout than (1) / (2), particularly so with ribbed slab and conventional beams i. e. types (c), (d)</p>	<p>type a and b: beams and ribs should have same thickness. narrow conventional beams may be precast and can either be post-tensioned or conventionally reinforced</p>	4
<p>economical formwork, no form stripping required, otherwise same as (4)</p>	<p>fire-rating of steel trough decking, less flexible services layout than (1) / (2), particularly so with conventional R. C. or steel beams (b), (c)</p>	<p>tendons are placed between the folds of the steel troughs</p>	5
<p>allows long spans in both directions and heavy loading, deflections can be kept small, can carry concentrated loads</p> <ul style="list-style-type: none"> for (a): tendons are easy to place for (b): very effective for load-balancing 	<p>formwork still more expensive than (2) / (4), beams interfere with services, particularly so with conventional beams i. e. types (c), (d)</p> <ul style="list-style-type: none"> for (a): less effective for load-balancing for (b): tendons are less easy to place 	<p>narrow conventional beams may be precast and can either be post-tensioned or conventionally reinforced</p>	6
<p>types (a) and (b) have less weight than (6) and (2) respectively for same spans and loading. attractive exposed ceilings great flexibility in services layout</p> <ul style="list-style-type: none"> tendons are easy to place, even for arrangement (b) 	<p>greater structural depth without paths for services (around drop panels or between beams) results in greater storey height or reduced ceiling space, expensive forms</p> <ul style="list-style-type: none"> type (a) less effective for load balancing 	<p>note: ideally the "beams" and "drops" have the same thickness as the waffle ribs</p>	7

POST-TENSIONED IN BUILDINGS

If large penetrations coincide with prestressing tendons some strengthening along the edges is required and must be installed prior to cutting, in the same way as for reinforced concrete floors.

There are no problems in cutting bonded tendons. The cut ends will act as bond anchorages so that the tendon is still effective over the remaining length. For unbonded tendons, VSL has developed a special jack which is used to grip the strands from the two ends either side of the cut so that the energy is released in a controlled way when the strands are cut. Before this jack can be applied the tendon must be exposed over a length of 1.0 to 1.5 m by carefully cutting away the surrounding concrete. When the strand has been cut the pressure on the jack is released, de-tensioning the tendon completely. After the penetration has been completed, new stressing anchorages are provided at the edges, the tendons cut to length and restressed with a normal stressing jack.

In summary, small floor penetrations and fixing holes are no problem but a certain amount of discipline is required by the trades. A well documented maintenance manual will certainly minimise the danger of unintentional cutting of prestressing tendons. Large floor penetrations are no problem either but require careful planning and design by an engineer, regardless of whether the floor is post-tensioned or not.

3.2 Moment-Resisting Frames

In this context frames are understood to consist of columns and beams rigidly connected to resist moments and shears from lateral and gravity loads. Figs. 3.1

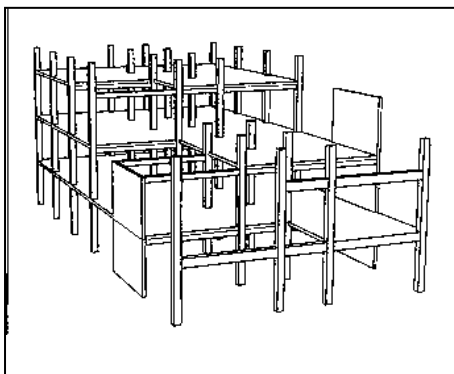

Fig. 3.1: Frames in a Low-Rise Building

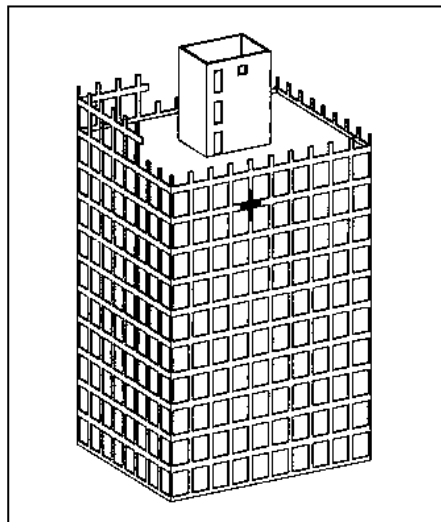

Fig. 3.2: Frames in a High-Rise Building

and 3.2 show examples of frames in a lowrise and a high-rise building, respectively. While for low-rise buildings the floor framing itself and its supporting columns may have sufficient stiffness and strength to resist wind loads, for medium and high-rise buildings it is usually necessary to provide shear walls, peripheral or internal frames, or both in order to brace the building against side sway, particularly so in seismic areas.

The construction of moment-resisting frames can be quite time consuming due to the often complex reinforcement, particularly in the beam-column joints and in end columns of frames that predominantly resist lateral loads. End columns typically carry relatively small gravity loads but large tension forces caused by lateral loads, which usually results in high reinforcement percentages. The beams in such frames often have considerable top and bottom reinforcement in the end portions to resist positive and negative moments resulting from the dominance of lateral loads. Replacing the dense reinforcement with a few high strength prestressing tendons can lead to substantial savings in construction time, since the remaining reinforcement is simple and can easily be pre-assembled in beam and column cages or even as entire cruciform cages. Post-tensioning of frames has the added advantage that the stiffness is increased or, conversely, the member sizes can be reduced. Both the beams and the columns can be post-tensioned. However, often only the end columns will warrant this. The beam tendons can be continuous from end to end of the frame,

either with parabolic drapes to balance gravity loads, or straight in the top and bottom of the beams, or as a combination of straight and draped tendons, depending on whether the design is dominated by gravity or lateral loads. The columns can either be post-tensioned by strand tendons continuous with couplers at every so many floors, or by stress bars coupled at every floor.

In order to reduce the construction time of moment-resisting frames, many contractors prefer to partly or completely precast the columns and beams which then only need to be erected and connected on site. In these cases post-tensioning offers the additional advantage that the prestress across the joints between precast elements provides sufficient clamping force to transfer shear in friction, avoiding reinforcing bar splices or couplers with the corresponding insitu concrete, or welded structural steel connectors. Because post-tensioned precast frames usually require only simple mortar joints they can be constructed quite expediently.

Fig. 3.3 shows three different arrangements of precast frames connected by post-tensioning tendons. The portion of the frame shown in each case is from mid-span to mid-span of adjacent bays and from mid-height to mid-height of two successive floors, as highlighted in Fig. 3.2. The beam tendons are continuous from one end of the frame to the other and are inserted into cast-in corrugated steel ducts and stressed after the mortar in the joints has hardened. The columns could be post-tensioned with strand tendons continuous over several storeys, or with stress bars coupled at every floor. It is evident that all elements must be temporarily propped and braced until all the tendons have been stressed.

Fig. 3.3(a) shows an arrangement suitable mainly for frames that predominantly resist gravity loads which explains why there are only draped tendons that pass through the columns near the top fibre of the beam. Fig. 3.3(b) and (c) show beams continuous through the column and a cruciform arrangement, respectively where the beams are joined at mid-span. These arrangements are more suitable than type (a) if the frame predominantly resists lateral loads. Then the moments at the beam

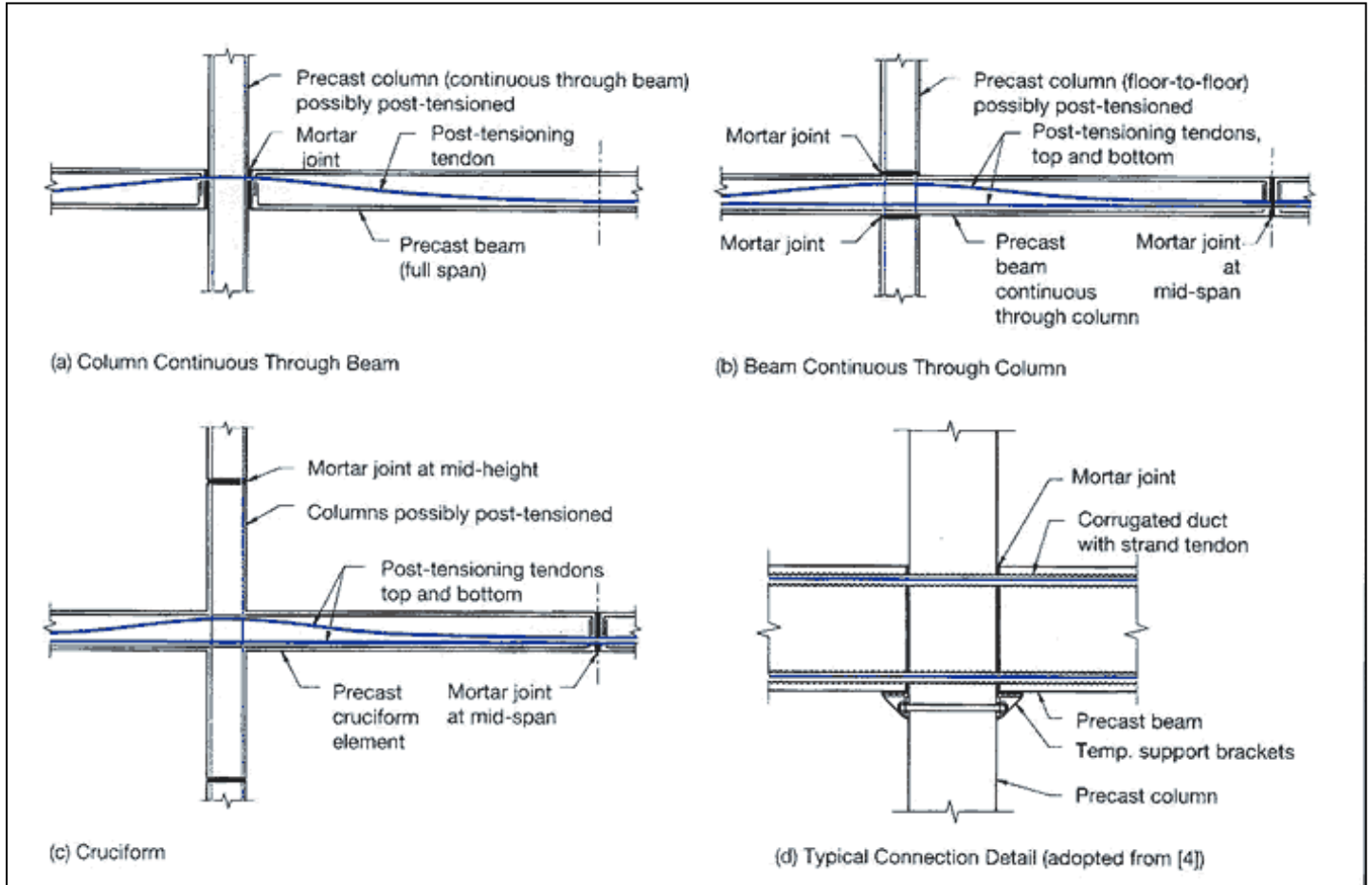

Fig. 3.3: Arrangements of Post-Tensioned Precast Frames (adopted from [3])

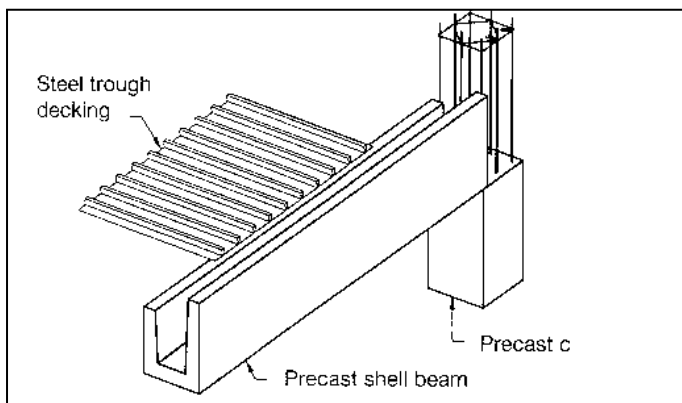

Fig. 3.4: Partly Precast Frame

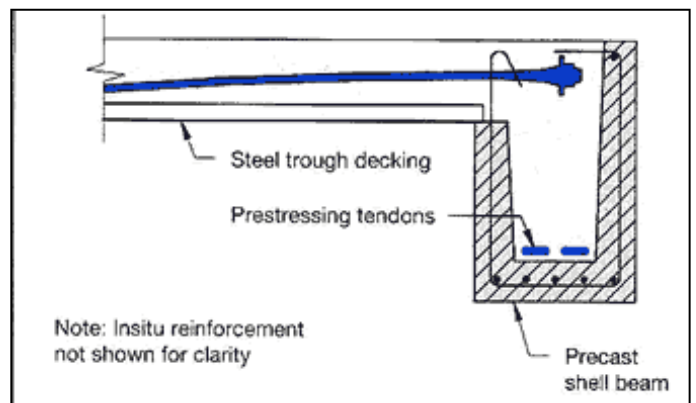

Fig. 3.5: Partly Precast Frame: Section through Beam

ends can be negative or positive and their magnitude is usually greater than at midspan which is why there are also some straight tendons in the bottom of the beam. The beam-column joint is within monolithic concrete so that some nonprestressed beam steel can pass through the column which significantly improves

the energy absorption capacity of seismic load resisting frames designed to form plastic hinges in the beams [3]. A possible detail of the joint of two full-span beams and a column is shown in Fig. 3.3(d). Temporary steel brackets stressed to the column are used to support the precast beams until the tendons have been stressed.

Another way to construct peripheral frames without the need for formwork is shown in Fig. 3.4. The beams are partly precast as shells containing the bottom steel and the stirrups, as shown in the cross section Fig. 3.5. The outside part of the shell is precast to full height so that no edge form is required. The inside part is

POST-TENSIONED IN BUILDINGS

precast to the level of the slab soffit and can support precast soffit panels or steel trough decking. The columns could be precast one or more storeys tall, either as fully precast units or as precast shells that are later filled with insitu concrete. In either case the joint is left free of concrete so that the top steel and the post-tensioning tendons can be readily placed. In this way the beams are monolithically connected with the slab and the columns. The beamcolumn joints behave similarly to cast-in-place joints, hence frames constructed in this way are adequate also in seismic regions [3].

In summary, the advantages of post-tensioning moment-resisting frames are:

- increase of frame stiffness and/or reduction of member sizes
- reduction of reinforcement percentages, thus simpler details and consequently faster construction cycle.

There are **added advantages for frames constructed of precast elements:**

- connections possess high strength and large stiffness
- simple mortar joints, no reinforcing bar laps or couplers and hardly any in-situ concrete requiring formwork
- no welded steel connectors with the corresponding high-level quality assurance procedures

3.3 Transfer Beams and Transfer Plates

In many high-rise hotel and office buildings large column-free lobbies are required at ground level, often extending over several floors, while the hotel or office floors above have columns and walls at much closer spacing. The transition from the small support grid to the large column spacing in the lobby is either by means of transfer beams or a transfer plate. In order to transfer the high concentrated forces from the columns and walls of the upper levels to the lower supports these beams and plates usually require considerable

depths and large reinforcement quantities. Post-tensioning is a very effective way to reduce both the depth and the reinforcement content. Fig. 3.6 shows the principle of a post-tensioned transfer beam. The prestressing force enables an arch system to form within the beam, transferring the column forces from the upper floors to the

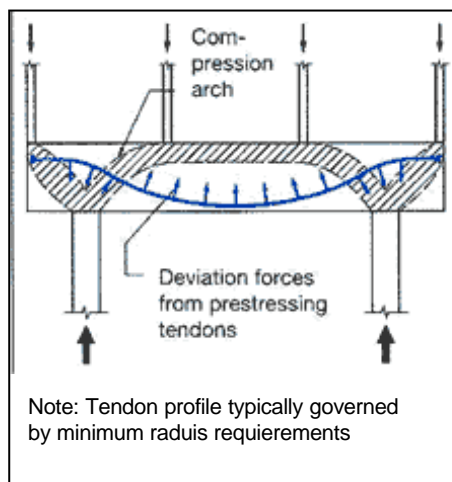
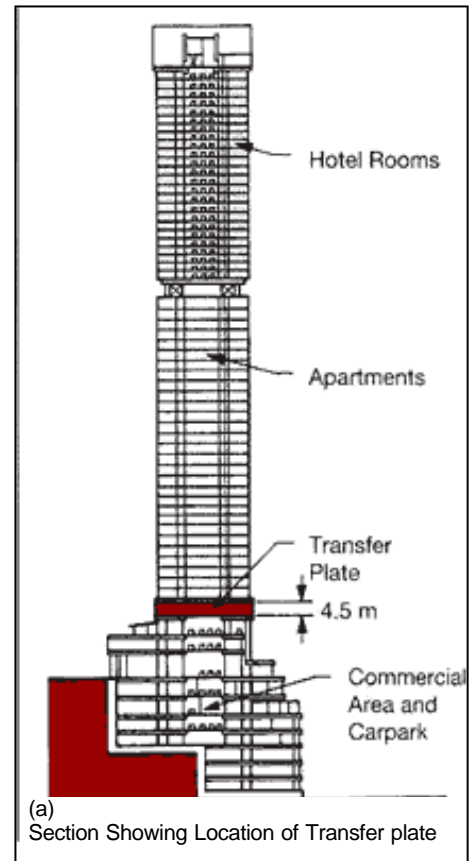

Fig. 3.6: Principle of Post-Tensioned Transfer Beam



(a) Section Showing Location of Transfer plate

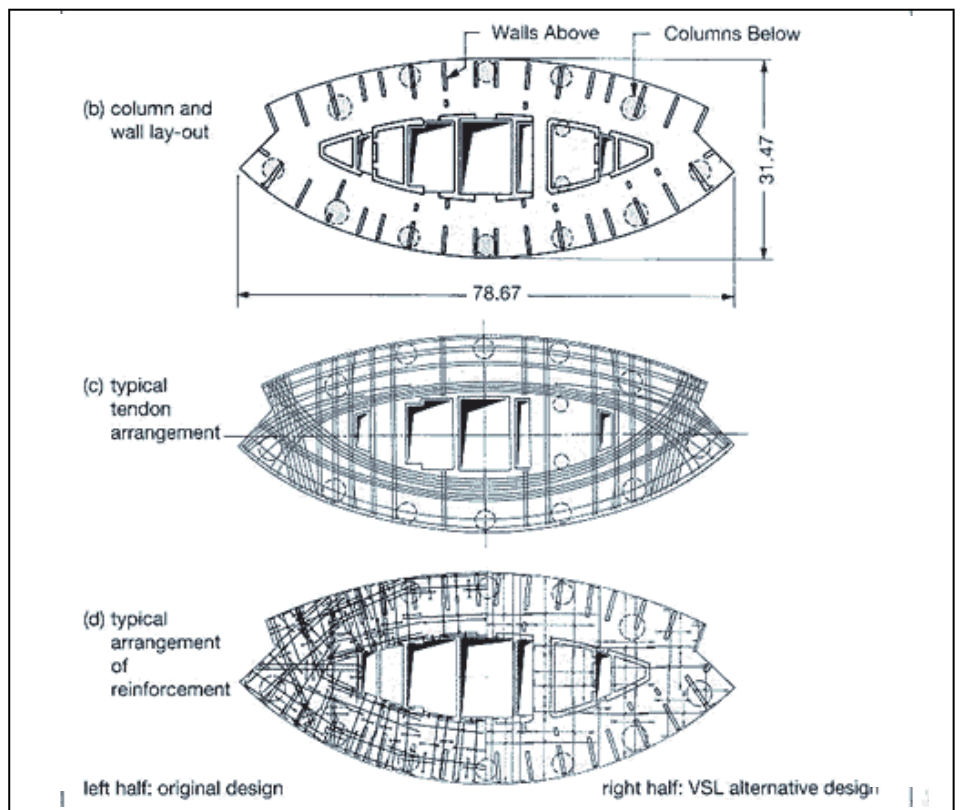

Fig. 3.7: Transfer Plate of Pacific Place, Hong Kong

POST-TENSIONED IN BUILDINGS

supports. Part of the loads, including the self weight of the beam, is balanced by the upward acting deviation forces from the parabolic tendons. The deflection is thus reduced considerably. The in-plane compression stress provided by the posttensioning tendons improves the cracking behaviour of the beam. As a guide line the post-tensioning should provide a minimum average in-plane compression stress of about 0.5 to 2.0 N/mm². The same principle applies to transfer plates. The draped tendons usually have to be stressed in stages as the construction of the upper storeys progresses. Otherwise the deviation forces from the fully prestressed tendons could cause a failure of the beam because they are not yet balanced by the full column loads from the upper storeys.

In some applications it will not be possible to drape the tendons because the corresponding radii would be smaller than the minimum recommended radius of curvature for the tendons. This is because the minimum thickness of transfer beams or plates is usually governed by

so that usually only a minimum crack distributing reinforcement is required in the extreme faces. Hence the reinforcement is simplified significantly which means that the construction time is reduced. This is particularly important because the timely completion of transfer beams or plates is crucial to the construction of the upper floors. Of course the cracking and deflection behaviour is also improved by straight post-tensioning tendons since they too provide an inplane compression stress.

An example of a large transfer plate is the one used in the Pacific Place building in Hong Kong [5]. This 4.5 m thick solid concrete slab transfers the loads from the closely spaced supports of the apartment / hotel complex to the widely spaced supports of the commercial / parking complex below as shown in Fig. 3.7 (a) and (b). The original design as a reinforced concrete slab required almost 500 kg/m³ of reinforcing steel. Owing to the very high shear forces, a reduction of the plate thickness was not practical, but a post

(right half). The reduced and simplified reinforcement permitted the contractor to complete the slab in a much shorter period of time. The layout of the posttensioning tendons is shown in Fig. 3.7 (c).

A variation of transfer beams and plates are stiff caps on top of high-rise buildings. They are either used to suspend floors constructed from top to bottom, using hangers (Fig. 3.8a), or to engage the peripheral columns to take part in resisting lateral loads in tension / compression in order to increase the lateral stiffness of the building (Fig. 3.8b).

In summary, **post-tensioning of transfer beams and plates offers the following advantages:**

- significant reduction of reinforcement, thus steel fixing is simplified, reducing construction time
- in many cases a reduction of the beam depth or plate thickness (i.e. total building height and weight is reduced and material saved)
- greater stiffness and hence better cracking and deflection behaviour

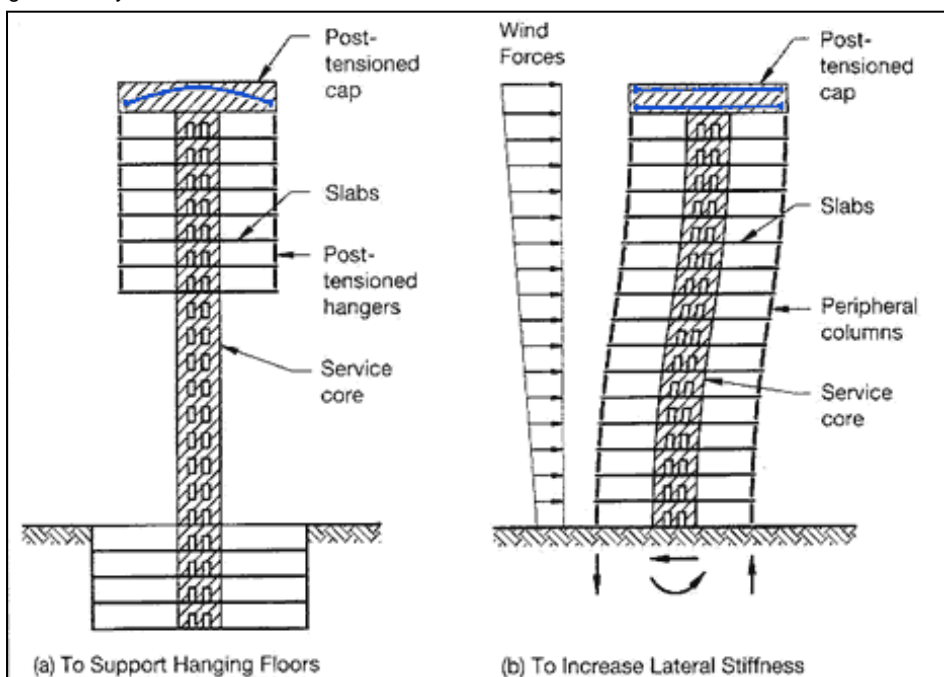

Fig. 3.8: Post-Tensioned Transfer Caps

shear force considerations. In those cases straight tendons are arranged in the top and in the bottom of the beam or plate, acting as chords. In that way arches similar to the system shown in Fig. 3.6 can develop. The bending moments are mainly resisted by the post-tensioning tendons

tensioned alternative design by VSL International Ltd. permitted reducing the reinforcement content to 180 kg/m³ while introducing only 27 kg/m³ of posttensioning strand. Fig. 3.7 (d) illustrates the typical reinforcement of the original (left half) and of the alternative design

3.4 Wall Panels and Service Cores

Reinforced concrete structural walls are used to brace framed building structures against side sway. Because these walls usually carry only relatively small gravity loads they require rather large quantities of vertical reinforcement in their extremities. These vertical bars, acting as tension chords, must be lap-spliced or coupled at every construction joint, or otherwise several meters long starter bars project from the pour level, hampering the concreting operations and posing a possible source of injuries. The replacement of most of the vertical reinforcement by high strength post-tensioning tendons therefore simplifies the steel fixing and thus results in overall construction time savings. Also, post-tensioning improves the cracking behaviour of concrete walls.

Similar to post-tensioned columns, the prestress can either be provided by strand tendons continuous over several storeys,

POST-TENSIONED IN BUILDINGS

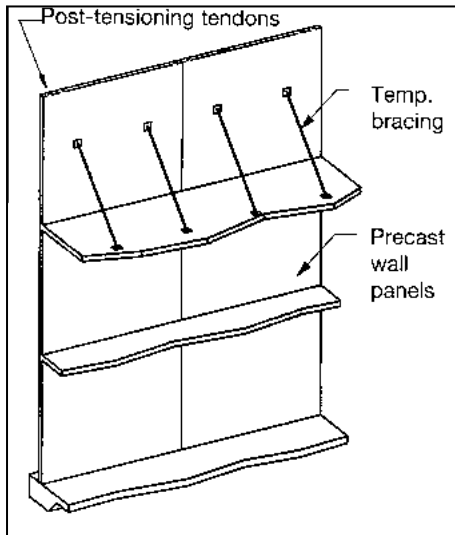

Fig. 3.9: Outside Shear Wall Constructed of Precast Panels Vertically PostTensioned

or by stress bars that are coupled at every storey. Strand tendons are inserted into cast-in corrugated ducts and coupled to dead-end anchorages provided at the wall base. After stressing from above the

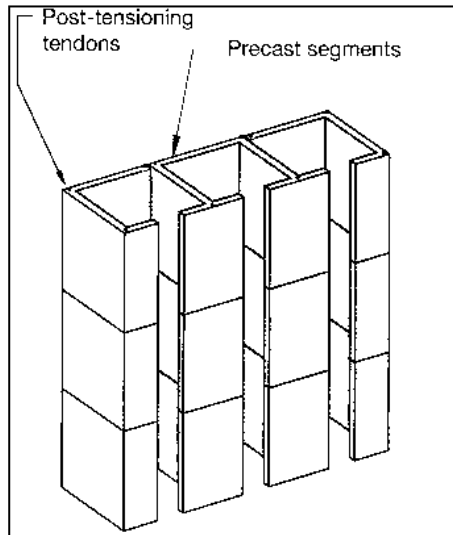

Fig. 3.11: Service Core Constructed of Precast Box Segments Vertically PostTensioned

ducts are then filled with cement grout for corrosion protection and to provide bond with the surrounding concrete. Provided the wall is temporarily sufficiently stable (braced by floor slabs and supple

concrete closing the gaps left for bar splices or steel connectors. Fig. 3.9 shows a typical outside shear wall of a mediumrise building under construction. There are two precast panels per floor. The principle of the horizontal connection detail is shown in Fig. 3.10(a). Tendons are located in corrugated steel ducts. A seating pocket is left for the slab. Shear keys and/or location dowels can be provided to centre the panels. Note that slab starter bars and shear keys or location dowels are not shown for clarity. The vertical joints do not need any formwork either (Fig. 3.10b). Overlapping hair pins provide the continuity of the horizontal reinforcement. The gap is filled with insitu concrete.

Provided that there is sufficient crane capacity, service cores can be constructed of precast box segments connected in the same way as shown for wall panels in Fig. 3.10. In this way it is possible to get the service core "out of the ground" in a rather short period of time, which is an important consideration with respect to the start time for floor construction. Since the box segments are stable under their

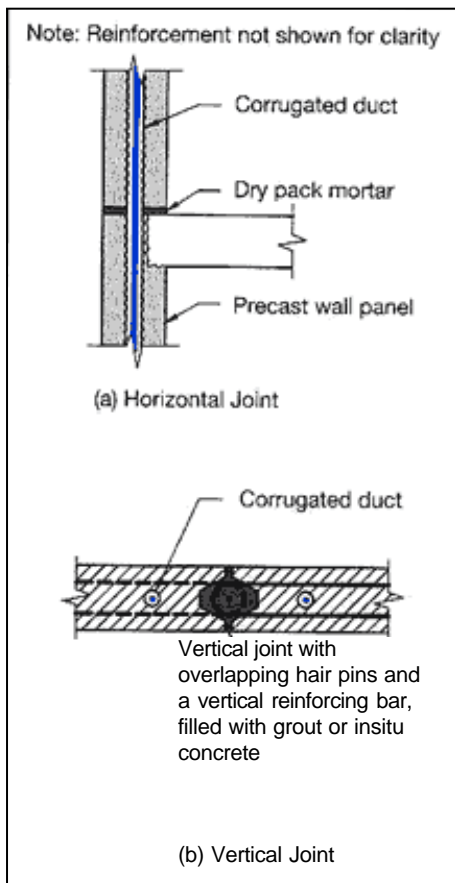

Fig. 3.10: Details of Wall Panel

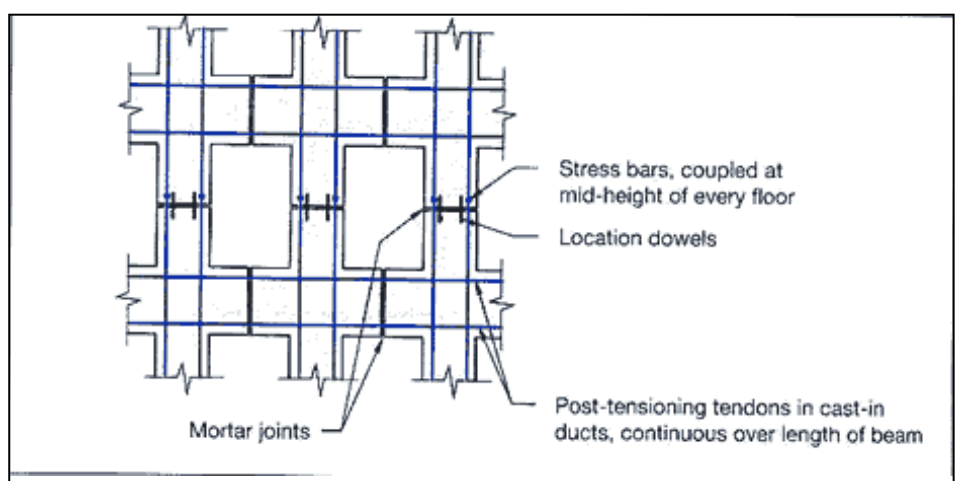

Fig. 3.12: Cruciform Wall Panels Post-Tensioned Together to Form a Perforated Wall

mentary bracing), the tendons need only be coupled at every so many floors.

For walls constructed of precast panels, post-tensioning offers the added advantage that the prestress provides an active clamping force to transfer shear across the interface between two panels in friction [6]. Hence the connections are simplified since neither welded steel connectors are required, nor do reinforcing bars need to be coupled. Consequently, there is no need for formwork for insitu

self weight they do not need temporary bracing. For the vertical tendons to act as chord reinforcement they are best located near the corners of the box cells. Fig. 3.11 shows a service core constructed of precast segments.

Another type of precast wall panels is shown in Fig. 3.12: Cruciform "Swiss Cross" panels can be used to build perforated concrete walls enclosing high-rise buildings of the "tube" type (Fig. 3.13).

Here too, only simple mortar joints are required if the panels are connected by post-tensioning. The horizontal strand tendons are continuous from end to end of the wall and are pushed or pulled into cast-in corrugated ducts. The vertical prestress is provided by stress bars coupled at mid-height of each floor. The panels must be temporarily braced for stabilization until all the tendons and bars have been stressed. The panels themselves contain only nominal shrinkage reinforcement. No reinforcing bars cross the joints. The straight prestressing tendons in both faces of the 'beams' and "columns" provide the required capacity to resist negative and positive bending moments as well as shear forces resulting from lateral loading.

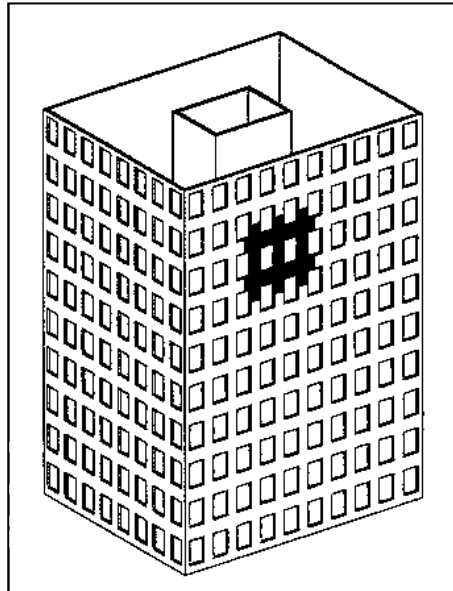

Fig. 3.13: Typical "Tube" Type Building The Part Shown in Fig. 3.12 is Highlighted

In summary, **the advantages of post-tensioning structural walls and service cores are**

- reduction of reinforcement percentages, thus simpler details and consequently faster construction cycle
- vertical tendons provide continuous chord reinforcement, no potential weak sections at multiple reinforcing bar laps

In addition, there are the following **advantages for walls and wall systems constructed of precast panels:**

- connections possess high strength and largestiffness
- simple mortar joints, no reinforcing bar laps or couplers and hardly any insitu concrete requiring formwork
- no welded steel connectors with the corresponding high-level quality assurance procedures
- increase of stiffness and/or reduction of member sizes of perforated outside walls of high-rise buildings of the "tube" type, particularly when assembled from precast cruciform panels

3.5 Post-Tensioned Foundations and Ground Anchors

The principle of a raft foundation is very similar to that of a floor slab turned upsidedown. The distributed soil pressure acts at the bottom surface and is held in equilibrium by the downward-acting concentrated forces from columns and walls. Similarly, a strip foundation acts like a beam turned upside-down. Fig. 3.14 illustrates three different types of foundation mats that are the equivalents of a flat plate, a flat slab with drop panels and a one-way slab / band beam system. Posttensioning of foundation mats or beams offers similar advantages as for floor systems: primarily reduction of the thickness and reinforcement quantity and the corresponding reduction of the construction time, and improvement of the cracking and deflection behaviour, which in turn results in an increase of the stiffness. The reduced raft thickness means less excavation and smaller concrete volume. The smaller concrete volume, in turn, permits faster placing and is less critical in terms of the development of hydration heat. Reduced steel content means less material to be placed and handled, and simpler reinforcing details mean faster steel fixing. The tendons can be arranged similar as in the corresponding slab types,

but with the parabolic drape inverted: low points under columns and walls, high points in the spans. Fig. 3.15 clearly shows the inverted tendon profiles in a raft foundation under construction. In many cases the foundation can be designed to act as a stiff box (Fig. 3.16). The walls can be posttensioned to reduce the wall thickness and the reinforcement content; and to improve the cracking behaviour.

For foundations with draped tendons it may be necessary to stress the tendons in stages as the building rises since otherwise the deviation forces arising from the tendon curvature under the columns would push off the columns which initially only carry a small portion of the final design load. A more comprehensive summary of the aspects to be considered in the design of post-tensioned foundations is given in [7].

A special form of post-tensioned foundations are ground anchors and tension piles (Fig. 3.17), which play an important role in resisting large overturning moments due to wind or earthquake loads, or in providing sufficient safety against buoyancy uplift. Finally it is worth mentioning under-ground tension members that provide the horizontal tie at the base of arch or shell structures or inclined columns (Fig. 3.18).

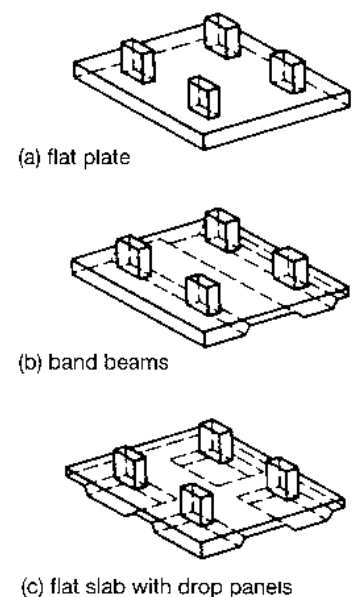

Fig. 3.14: Different Types of Raft Foundations

POST-TENSIONED IN BUILDINGS

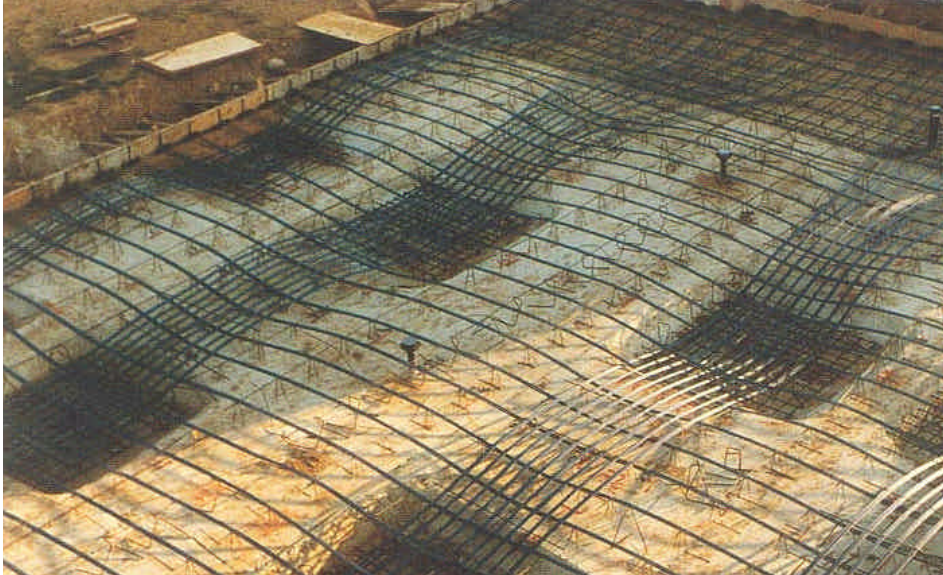

Fig. 3.15: A Post-Tensioned Raft Foundation under Construction

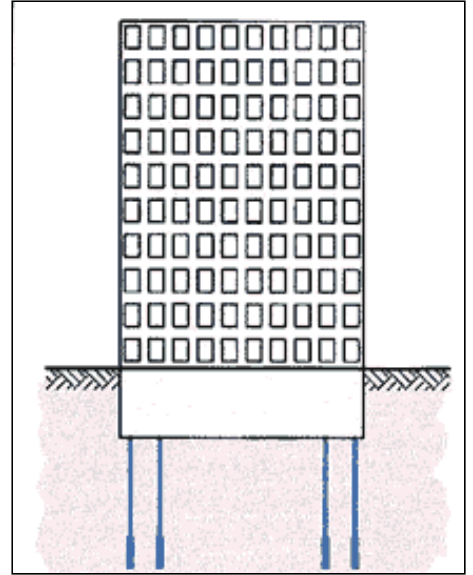

Fig. 3.17 Ground Anchors and Tension Piles

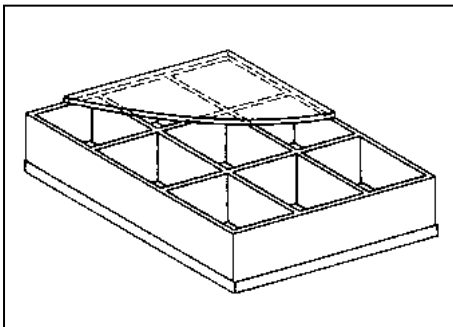

Fig. 3.16: Stiff Basement Box

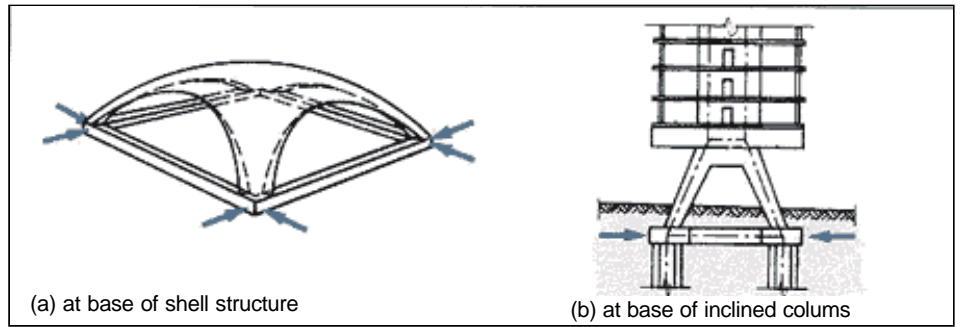

Fig. 3.18: Under-Ground Tension Ties

3.6 Post-Tensioned Masonry Walls

Masonry walls usually carry only small, if any, super-imposed gravity loads. Unless they are reinforced they therefore possess relatively small flexural strength both in-plane and out of plane. Unreinforced masonry walls have the additional disadvantage of failing in a brittle mode once the tensile capacity of the joints is exceeded. Vertical post-tensioning tendons placed in the cores significantly increase the strength and ductility of masonry walls. The VSL post-tensioning system for masonry uses unbonded greased and plastic-sheathed strands ('monostrands') that are inserted into steel pipes placed in sections while the blocks or bricks are laid (Fig. 3.19). This is a far less time consuming operation than placing bonded non-prestressed reinforcement. Selfactivating anchorages are placed at the base of the wall which grip the strands

when inserted. The tendons are stressed from the top of the wall. More detailed information on post-tensioned masonry is contained in [8].

3.7 Other Applications

In addition to floor systems, moment-resisting frames, transfer beams and plates, shear walls and service cores, foundations, ground anchors and masonry walls there are some special applications. These include stay cables to support large roof structures, or used as back-tie: for large cantilever supports of grand stands or hangar roofs. They also include cable roofs, tension ties at the base of inclined columns or arches, and tension columns suspending floors from a cap at the top of a high-rise building ("hanging structures"). These applications are not discussed further.

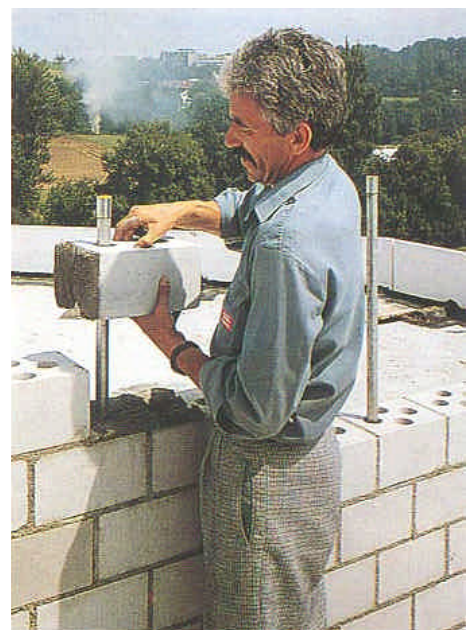

Fig. 3.19: Steel Ducts for Vertical Tendons Placed in Cores of Masonry